

ELITE 25 SP

GENERAL FEATURES

Aluminium truss, main tube $\text{Ø} 50 \text{ mm} \times 2 \text{ mm}$ and diagonal tube $\text{Ø} 12 \text{ mm} \times 1,5 \text{ mm}$, in aluminium melted flanges. This is the perfect balance between aesthetics and strength, performance and cost.

COUPLING SYSTEM

Elite model gives the user the chance to choose between two different connection systems. These meet the demands of professionals and installers.

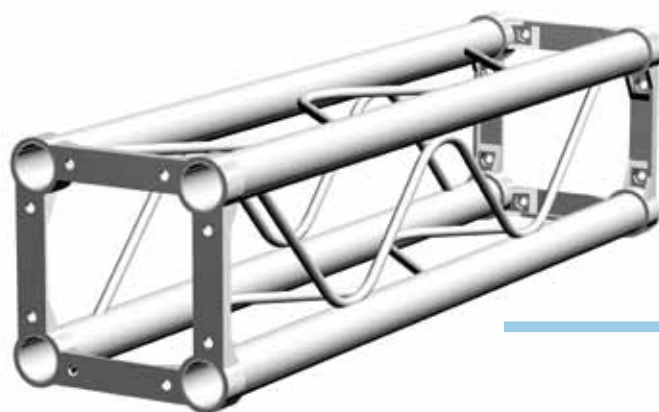

Ladder

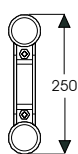

Trio

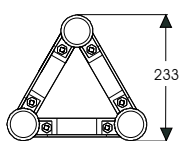

Square

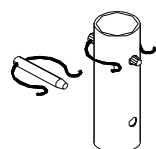
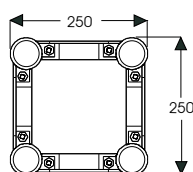

TB 5000
Elite coupling
Set

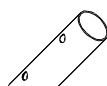

TA 6001
Standard spigot



TA 8002
Quick clip

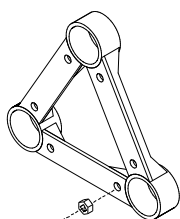

TA 6004
Coupling Set
always provided



TRUSS LENGTH	LADDER CODE	LADDER WEIGHT	TRIO CODE	TRIO WEIGHT	SQUARE CODE	SQUARE WEIGHT
0,5 m	TB 13205	1,87 kg	TB 13305	3,23 kg	TB 13405	4,26 kg
1,0 m	TB 13210	2,96 kg	TB 13310	4,94 kg	TB 13410	6,47 kg
1,5 m	TB 13215	4,06 kg	TB 13315	6,64 kg	TB 13415	8,68 kg
2,0 m	TB 13220	5,15 kg	TB 13320	8,35 kg	TB 13420	10,88 kg
2,5 m	TB 13225	6,25 kg	TB 13325	10,05 kg	TB 13425	13,09 kg
3,0 m	TB 13230	7,35 kg	TB 13330	11,76 kg	TB 13430	15,30 kg
3,5 m	TB 13235	8,44 kg	TB 13335	13,47 kg	TB 13435	17,50 kg
4,0 m	TB 13240	9,54 kg	TB 13340	15,17 kg	TB 13440	19,71 kg

TRUSS LENGTH	LADDER				TRIO				SQUARE			
	▲		▲▲▲▲		▲		▲▲▲▲		▲		▲▲▲▲	
CONNECTION SYSTEM: CONNECTOR OR BOLT												
4 m	140	57	70	27	220	196	110	98	400	224	175	115
6 m	83	34	26	11	135	125	45	41	250	140	84	50
8 m	56	21	14	5	96	90	24	22	180	96	45	27
10 m	36	12	7	2	70	65	14	13	140	67	28	16
12 m	22	-	5	-	54	48	9	7	107	45	18	11
14 m	-	-	-	-	-	-	-	-	83	29	12	7

LOADING FIGURES